



Refrigerated Sushi Showcases

Models RS-CN-0044, 0064, 0084, 0104

Items 43492, 44393, 44394, 44395

Instruction Manual



Revised - 06/16/2022



Toll Free: 1-800-465-0234
Fax: 905-607-0234
Email: service@omcan.com
www.omcan.com

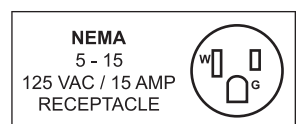

Table of Contents

Model RS-CN-0044 / Model RS-CN-0064
Model RS-CN-0084 / Model RS-CN-0104

Section	Page
Disclaimer -----	3
General Information -----	4 - 5
Safety and Warranty -----	5 - 7
Technical Specifications -----	8
Operation -----	8 - 9
Maintenance -----	9 - 10
Troubleshooting -----	10
Parts Breakdown -----	11 - 18
Electrical Schematics -----	19
Notes -----	20 - 22
Warranty Registration -----	23

OMCAN IS NOT RESPONSIBLE FOR ANY DAMAGES DUE TO WATER LEAKS. WARRANTY FOR WATER LEAKS IS VOID IF THE AMBIENT ROOM TEMPERATURE EXCEEDS 75°F AND 55% RELATIVE HUMIDITY, AND THE APPLIANCE DRAIN IS NOT CONNECTED DIRECTLY TO A FLOOR DRAIN.

General Information

Omcan Manufacturing and Distributing Company Inc., Food Machinery of America, Inc. dba Omcan and Omcan Inc. are not responsible for any harm or injury caused due to any person's improper or negligent use of this equipment. The product shall only be operated by someone over the age of 18, of sound mind, and not under the influence of any drugs or alcohol, who has been trained in the correct operation of this machine, and is wearing authorized, proper safety clothing. Any modification to the machine voids any warranty, and may cause harm to individuals using the machine or in the vicinity of the machine while in operation.

CHECK PACKAGE UPON ARRIVAL

Upon receipt of an Omcan shipment please inspect for external damage. If no damage is evident on the external packaging, open carton to ensure all ordered items are within the box, and there is no concealed damage to the machine. If the package has suffered rough handling, bumps or damage (visible or concealed), please note it on the bill of lading before accepting the delivery and contact Omcan within 24 hours, so we may initiate a claim with the carrier. A detailed report on the extent of the damage caused to the machine must be filled out within three days, from the delivery date shown in the shipping documents. Omcan has no recourse for damaged products that were shipped collect or third party.

Before operating any equipment, always read and familiarize yourself with all operation and safety instructions.

Omcan would like to thank you for purchasing this machine. It's of the utmost importance to save these instructions for future reference. Also save the original box and packaging for shipping the equipment if servicing or returning of the machine is required.

Omcan Fabrication et distribution Compañie Limité et Food Machinery d'Amérique, dba Omcan et Omcan Inc. ne sont pas responsables de tout dommage ou blessure causé du fait que toute personne ait utilisé cet équipement de façon irrégulière. Le produit ne doit être exploité que par quelqu'un de plus de 18 ans, saine d'esprit, et pas sous l'influence d'une drogue ou d'alcool, qui a été formé pour utiliser cette machine correctement, et est vêtu de vêtements de sécurité approprié. Toute modification de la machine annule toute garantie, et peut causer un préjudice à des personnes utilisant la machine ou des personnes à proximité de la machine pendant son fonctionnement.

VÉRIFIEZ LE COLIS DÈS RÉCEPTION

Dès réception d'une expédition d'Omcan veuillez inspecter pour dommages externes. Si aucun dommage n'est visible sur l'emballage externe, ouvrez le carton afin de s'assurer que tous les éléments commandés sont dans la boîte, et il n'y a aucun dommage dissimulé à la machine. Si le colis n'a subi aucune mauvaises manipulations, de bosses ou de dommages (visible ou cachée), notez-le sur le bond de livraison avant d'accepter la livraison et contactez Omcan dans les 24 heures qui suivent, pour que nous puissions engager une réclamation auprès du transporteur. Un rapport détaillé sur l'étendue des dommages causés à la machine doit être rempli dans un délai de trois jours, à compter de la date de livraison indiquée dans les documents d'expédition. Omcan n'a aucun droit de recours pour les produits endommagés qui ont été expédiés ou cueilli par un tiers transporteur.

General Information

Avant d'utiliser n'importe quel équipement, toujours lire et vous familiariser avec toutes les opérations et les consignes de sécurité.

Omcan voudrais vous remercier d'avoir choisi cette machine. Il est primordial de conserver ces instructions pour une référence ultérieure. Également conservez la boîte originale et l'emballage pour l'expédition de l'équipement si l'entretien ou le retour de la machine est nécessaire.

Omcan Empresa De Fabricacion Y Distribucion Inc. Y Maquinaria De Alimentos De America, Inc. dba Omcan y Omcan Inc. no son responsables de ningun daño o perjuicio causado por cualquier persona inadecuada o el uso descuidado de este equipo. El producto solo podra ser operado por una persona mayor de 18 años, en su sano juicio y no bajo alguna influencia de droga o alcohol, y que este ha sido entrenado en el correcto funcionamiento de esta máquina, y ésta usando ropa apropiada y autorizada. Cualquier modificación a la máquina anula la garantía y puede causar daños a las personas usando la máquina mientras esta en el funcionamiento.

REVISE EL PAQUETE A SU LLEGADA

Tras la recepcion de un envio Omcan favor inspeccionar daños externos. Si no hay daños evidentes en el empaque exterior, Habra el carton para asegurarse que todos los articulos solicitados estén dentro de la caja y no encuentre daños ocultos en la máquina. Si el paquete ha sufrido un manejo de poco cuidado, golpes o daños (visible o oculto) por favor anote en la factura antes de aceptar la entrega y contacte Omcan dentro de las 24 horas, de modo que podamos iniciar una reclamación con la compañía. Un informe detallado sobre los daños causados a la máquina debe ser llenado en el plazo de tres días, desde la fecha de entrega que se muestra en los documentos de envío. Omcan no tiene ningun recurso por productos dañados que se enviaron a recoger por terceros.

Antes de utilizar cualquier equipo, siempre lea y familiarizarse con todas las instrucciones de funcionamiento y seguridad.

Omcan le gustaría darle las gracias por la compra de esta máquina. Es de la mayor importancia para salvar estas instrucciones para futuras consultas. Además, guarda la caja original y el embalaje para el envío del equipo si servicio técnico o devolución de la máquina que se requiere.

Safety and Warranty

1. A high quality, fully enclosed compressor is used in this product and utilizes the R134a or R290 refrigerant which is an environmentally friendly gas. A forced air refrigeration system is used which ensures that the temperature is very even throughout the case.
2. Glazing is used throughout the product for maximum visibility and two rear mounted sliding doors allow easy access.
3. The horizontal showcase has a wide range of uses including convenience stores, bakery outlets and other food service establishments as well as offices and even homes.

Safety and Warranty

4. Always allow a time of around 2 hours between moving the unit and restarting it.

HANDLING AND PLACEMENT

- **Handle with care.**
Unplug the wall socket first. Never tilt it over 45 degree during handling.
- **Dry place.**
Always locate the refrigerator at a dry place.
- **Sufficient space.**
The distance from both sides and back of refrigerator to wall or other substance must not less than 10cm. The refrigeration capability might be decreased if its surround space is too small to circulate air.
- **Well ventilation.**
Always locate the refrigerator at a place with fine ventilation. For the first time use, wait for 2 hours after handling and then plug the wall socket and start it.
- **Far from heat source.**
Never place the refrigerator directly under the sunshine. Never locate it nearby any heat source or heater to prevent it from reducing refrigeration capability.
- **No heavy load.**
Never put any heavy load on the top of the refrigerator.
- **No hole making.**
Never make hole on the refrigerator. Never install other matter on the refrigerator.
- **Stable location.**
Unpacking and locate the refrigerator on a flat and solid place.
- **Exclusive power socket.**
Normally, the power supply should be 220-240V, single phase AC with exclusive single phase three pin receptacle (250V 10A) and fuse (6A). The power receptacle must have a reliable earth connection.
- **No share on socket.**
Never let the refrigerator share the common socket with other appliance, otherwise the cable becomes hot and fire might be resulted.
- **Protect cables.**
Never break or damage the cables otherwise current leakage and fire might be resulted.
- **No water flushing.**
Never give the refrigerator surface a flush otherwise current leakage might be resulted.
- **Prevent from flammables and explosive.**
Never put any flammable or explosive inside the refrigerator such as ether, gasoline, alcohol, adhesive and explosive. Never put dangerous product nearby the refrigerator.
- **No spray.**
To spray the flammables such as paint or coating nearby the refrigerator is not allowed, otherwise fire might be resulted.
- **After power break.**
After power break or unplugging the refrigerator, always wait at least 5 minutes and then you may plug the refrigerator and start it again.
- **No medicine.**
No medicine is allowed to keep inside the refrigerator.



Safety and Warranty

RESIDENTIAL USERS: Vendor assumes no liability for parts or labor coverage for component failure or other damages resulting from installation in non-commercial or residential applications. The right is reserved to deny shipment for residential usage; if this occurs, you will be notified as soon as possible.

1 YEAR PARTS AND LABOUR BENCH WARRANTY

Within the warranty period, contact Omcan Inc. at 1-800-465-0234 to schedule a drop off to either an Omcan authorized service depot in the area, or to an Omcan Service warehouse to repair the equipment.

Unauthorized maintenance will void the warranty. Warranty covers electrical and part failures, not improper use.

Please see <https://omcan.com/disclaimer> for complete info.

WARNING:

The packaging components are classified as normal solid urban waste and can therefore be disposed of without difficulty.

In any case, for suitable recycling, we suggest disposing of the products separately (differentiated waste) according to the current norms.

DO NOT DISCARD ANY PACKAGING MATERIALS IN THE ENVIRONMENT!

Technical Specifications

Model	RS-CN-0044	RS-CN-0064	RS-CN-0084	RS-CN-0104
Volume	44 L / 1.55 cu.ft.	64 L / 2.26 cu.ft.	84 L / 2.96 cu.ft.	104 L / 3.67 cu.ft.
Power	160 W			
Refrigerant	R290			R134A
Storage Temperature	0 - 12°C / 32 - 53.6°F			
Electrical	110V / 60Hz / 1			
Number of Pans	4 x 1/3 GN	5 x 1/3 GN	6 x 1/3 GN	5 x 1/2 GN
Dimensions	44.5" x 15.6" x 14.7" 1131 x 395 x 375mm	51.4" x 15.6" x 14.7" 1307 x 395 x 375mm	58.4" x 15.6" x 14.7" 1483 x 395 x 375mm	69" x 15.6" x 14.7" 1754 x 395 x 375mm
Packaging Dimensions	46.7" x 18.3" x 16.9" 1187 x 465 x 430mm	53.7" x 18.3" x 16.9" 1363 x 465 x 430mm	60.6" x 18.3" x 16.9" 1539 x 465 x 430mm	71.3" x 18.3" x 16.9" 1810 x 465 x 430mm
Weight	86 lbs. / 39 kgs.	94.8 lbs. / 43 kgs.	103.6 lbs. / 47 kgs.	116.8 lbs. / 53 kgs.
Packaging Weight	92.6 lbs. / 42 kgs.	101.4 lbs. / 46 kgs.	110.2 lbs. / 50 kgs.	125.7 lbs. / 57 kgs.
Item Number	43492	44393	44394	44395

Operation

BEFORE USE

Plug the fridge in to an exclusive 110V~ socket. Once the fridge has been running place your hand on the air extractor to confirm that it is sufficiently cold once you are happy then you may put food inside.

DIGITAL TEMPERATURE CONTROLLER

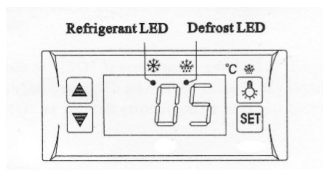



FEATURES OF FUNCTION

- It is a mini-sized and integrated intelligent controller and applicable to the compressor of one HP. The main functions are: Temperature Display, Temperature Control, Manual/Automatic Defrost by Burning Off, Illumination Control, Value Storing, Self Testing, Parameter Locking.

FRONT PANEL OPERATION

- Set temperature:
Press the "SET" button, the set temperature is displayed.
Press \triangle or ∇ button to modify and store the displayed value.
Press the "SET" button to exit the adjustment and display the cold-room temperature.
- If no more button is pressed within 10 seconds, the cold-room temperature will be displayed.

Operation

3. Illumination: Press the  button, it lights; Press again, it stops.
Manual Start/Stop Defrost: Press the  button and hold for 6 seconds to defrost or stop defrost.
4. Refrigerant LED: During refrigeration, the LED is on; When the cold room temp. is constant, the LED is off; During the delay start, the LED flashes.
5. Defrost LED: during defrosting, the LED is on; When is stops defrosting, the LED is off, During the delay display of defrost, the LED flashes.

SAFETY WARNINGS

- When opening the door try to reduce the length of time that it is open for in order to keep the temperature inside cold.
- Do not overload the unit food as it will affect the cooling ability.
- Always cool hot food down to room temperature before placing it in the fridge.
- The unit should only be maintained by a professional engineer.
- Never touch the compressor as it may be hot and burn you.
- If the power cord is damaged it must be replaced by the manufacturer or a professional engineer.
- Children should be supervised at all times to ensure they are not hurt by the unit.
- This appliance is not intended for use by persons (including children) with reduced physical, sensory or mental capabilities, or lack of experience and knowledge, unless they have been given supervision or instruction concerning use of the appliance by a person responsible for their safety.
- Children should be supervised to ensure that they do not play with the appliance.

WARNING: Keep ventilation openings clear of obstruction at all times.

WARNING: Do not use mechanical devices or any other means of accelerated defrosting unless recommended by the manufacturer.

WARNING: Do not damage or modify the refrigeration circuit.

WARNING: Do not use electrical appliances inside the food storage areas unless they are recommended by the manufacturer.

ADDITIONAL WARNING:

Caution: Risk of fire. The height of the triangle in the symbol shall be at least 15mm.



Important: The top glass shelf must not be used for keeping products refrigerated, only use the GN pans to store refrigerated products.

Maintenance

- Often keep the refrigerator clean and periodical maintenance is necessary.
- Always unplug the socket before maintenance.
- Never use damaged plug or loose socket to prevent from electric shock or short circuit.
- Never flush the refrigerator. Never use alkali detergent, soap, gasoline, acetone or brush.

Maintenance

CLEANING

1. Clean outside

- Moisten soft cloth in a mild detergent solution to clean the outside, and then wipe off with a dry soft cloth.

2. Clean inside

- Remove the tray and clean with water.
- Use a soft, damp cloth to wipe the interior.

3. Turning off for prolonged periods

- Take out all food and unplug the unit from the wall.
- Clean both the inside and outside of the fridge thoroughly and open the door to allow it to dry.
- Be careful as the glass can easily be broken.

4. Replacement of the light

- If the LED is damaged it must be replaced by the manufacturer or their service agent.

Troubleshooting

Trouble	Cause	Remedy
Unit not cooling.	Is the plug in the socket correctly?	Check the plug.
	Is the fuse blown?	Check fuse and replace if needed.
	Is there no power from the socket?	Plug another unit into the socket to check if it works.
Unit not cooling enough.	Is it in direct sunlight or near a heat source?	Move away from the heat source.
	Is the surrounding area bad for ventilation?	Move to an area with improved ventilation.
	Does the door close correctly? Is the door left open?	Check the door.
	Is the unit too full?	Remove some food.
	Is the temperature controller set correctly?	Check the controller.
Loud operation noise.	The fridge is not sitting level.	Move to a flat surface.
	The fridge is vibrating against something else.	Move the unit so it is not touching anything.
	There is loose part in the refrigerator.	Check the interior for loose parts and tighten.
Contact your local Omcan Service Agent for help if simple trouble shooting does not solve the problems.		

Parts Breakdown

Model RS-CN-0044 43492

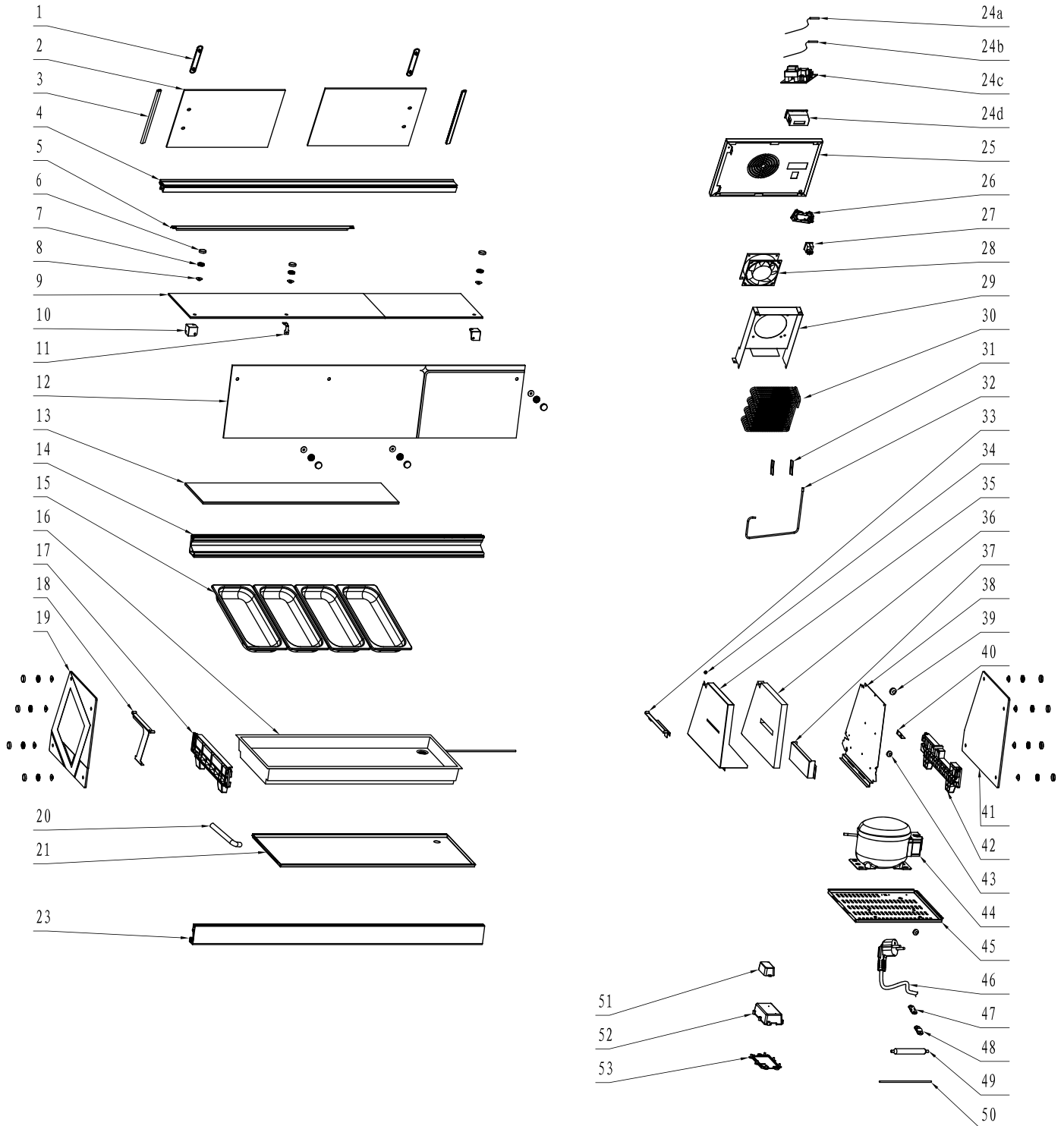

Parts Breakdown

Model RS-CN-0044 43492

Item No.	Description	Position	Item No.	Description	Position	Item No.	Description	Position
66232	Handle for 43492	1	66245	Left Side Glass for 43492	19	66255	Median Septum for 43492	38
66233	Door Glass for 43492	2	60105	Water Discharge Pipe for 43492	20	60756	14mm Protecting Coil for 43492	39
66234	A-Type Sealing Strip for 43492	3	60106	Bottom Panel for 43492	21	66256	Fixed Plate of Median Septum for 43492	40
66235	Upper Pillar for 43492	4	66246	Front Pillar for 43492	23	66257	Right Side Glass for 43492	41
66236	LED for 43492	5	66247	Temperature Controller Assembly for 43492	24	66258	Right Side Plate for 43492	42
60101	Decorating Gasket of Nut for 43492	6	66248	Back Board for 43492	25	66259	12mm Protective Ring for 43492	43
60102	Nut Decorating Parts for 43492	7	60125	Digital Controller Holder for 43492	26	60138	Compressor for 43492	44
60103	Big Gasket of Nut for 43492	8	71514	Switch for 43492	27	66260	Compressor Base Board for 43492	45
66237	Upper Glass for 43492	9	60126	Fan Motor for 43492	28	60115	Power Cord for 43492	46
66238	Fixed Angle for 43492	10	66249	Condenser Backplate for 43492	29	61246	Wire Clip Holder for 43492	47
66239	Glass Bracket for 43492	11	60135	Condenser for 43492	30	61245	Wire Clip Cover for 43492	48
66240	Front Glass for 43492	12	60134	Square Gasket for 43492	31	60144	Dry Filter for 43492	49
66241	Glass Shelf for 43492	13	66250	Joint Pipe for 43492	32	60143	Filling Pipe for 43492	50
66242	Back Pillar for 43492	14	66251	Right Support for Glass Shelf for 43492	33	60145	#6 Driver for 43492	51
60098	1/3 GN Pan for 43492	15	60114	5mm Protective Ring for 43492	34	60137	Controller Box for 43492	52
60104	Foam Material for 43492	16	66252	Cover of Median Septum for 43492	35	60136	Controller Panel for 43492	53
66243	Left Side Plate for 43492	17	66253	EVA Cotton of Median Septum for 43492	36			
66244	Left Support for Glass Shelf for 43492	18	66254	Support of Median Septum for 43492	37			

Parts Breakdown

Model RS-CN-0064 44393

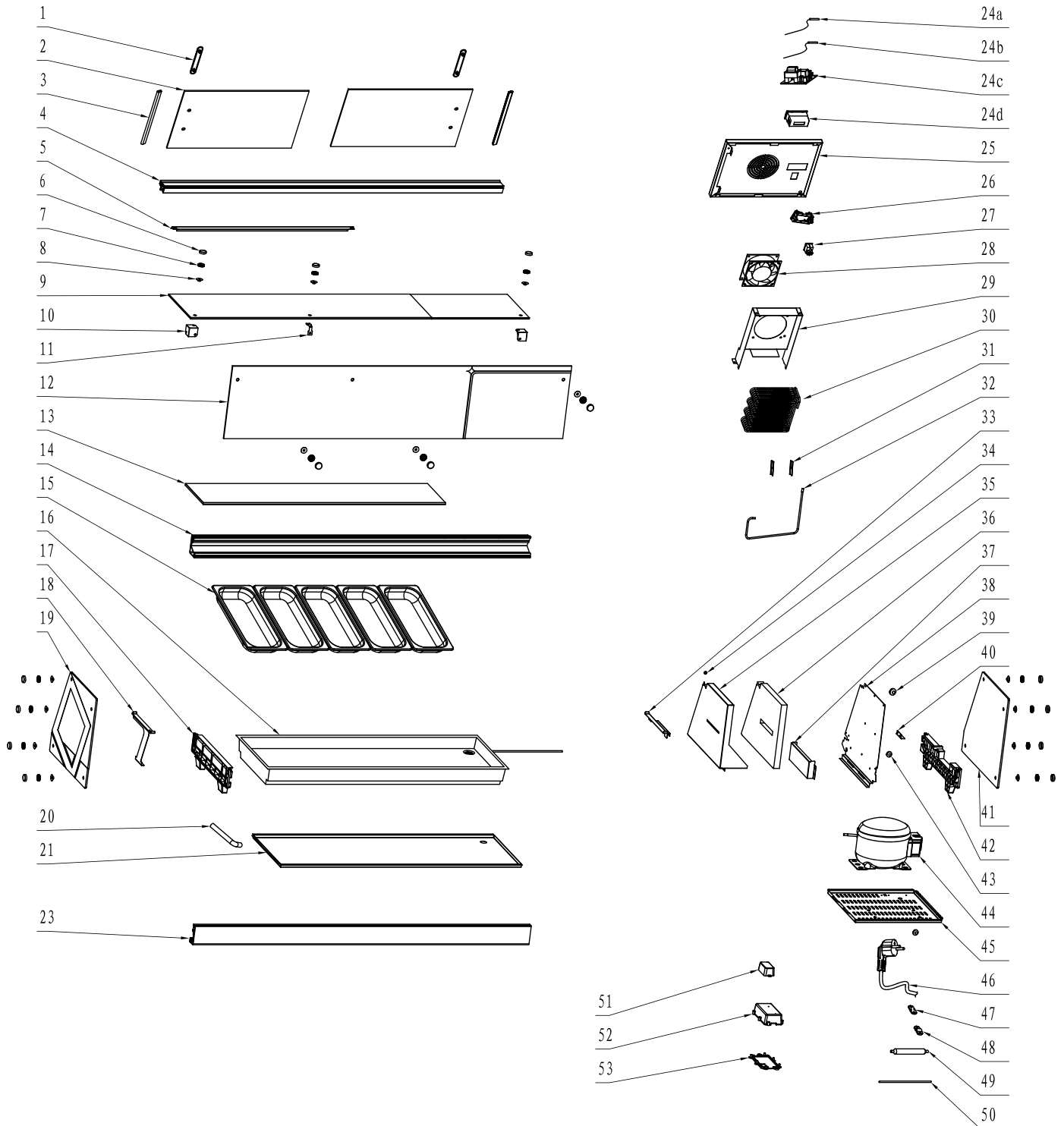

Parts Breakdown

Model RS-CN-0064 44393

Item No.	Description	Position	Item No.	Description	Position	Item No.	Description	Position
66232	Handle for 44393	1	66245	Left Side Glass for 44393	19	66255	Median Septum for 44393	38
66261	Door Glass for 44393	2	60105	Water Discharge Pipe for 44393	20	60756	14mm Protecting Coil for 44393	39
66234	A-Type Sealing Strip for 44393	3	60154	Bottom Panel for 44393	21	66256	Fixed Plate of Median Septum for 44393	40
66262	Upper Pillar for 44393	4	66267	Front Pillar for 44393	23	66257	Right Side Glass for 44393	41
66236	LED for 44393	5	66247	Temperature Controller Assembly for 44393	24	66258	Right Side Plate for 44393	42
60101	Decorating Gasket of Nut for 44393	6	66248	Back Board for 44393	25	66259	12mm Protective Ring for 44393	43
60102	Nut Decorating Parts for 44393	7	60125	Digital Controller Holder for 44393	26	60138	Compressor for 44393	44
60103	Big Gasket of Nut for 44393	8	71514	Switch for 44393	27	66260	Compressor Base Board for 44393	45
66263	Upper Glass for 44393	9	60126	Fan Motor for 44393	28	60115	Power Cord for 44393	46
66238	Fixed Angle for 44393	10	66249	Condenser Backplate for 44393	29	61246	Wire Clip Holder for 44393	47
66239	Glass Bracket for 44393	11	60135	Condenser for 44393	30	61245	Wire Clip Cover for 44393	48
66264	Front Glass for 44393	12	60134	Square Gasket for 44393	31	60144	Dry Filter for 44393	49
66265	Glass Shelf for 44393	13	66250	Joint Pipe for 44393	32	60143	Filling Pipe for 44393	50
66266	Back Pillar for 44393	14	66251	Right Support for Glass Shelf for 44393	33	60145	#6 Driver for 44393	51
60098	1/3 GN Pan for 44393	15	60114	5mm Protective Ring for 44393	34	60137	Controller Box for 44393	52
60153	Foam Material for 44393	16	66252	Cover of Median Septum for 44393	35	60136	Controller Panel for 44393	53
66243	Left Side Plate for 44393	17	66253	EVA Cotton of Median Septum for 44393	36			
66244	Left Support for Glass Shelf for 44393	18	66254	Support of Median Septum for 44393	37			

Parts Breakdown

Model RS-CN-0084 44394

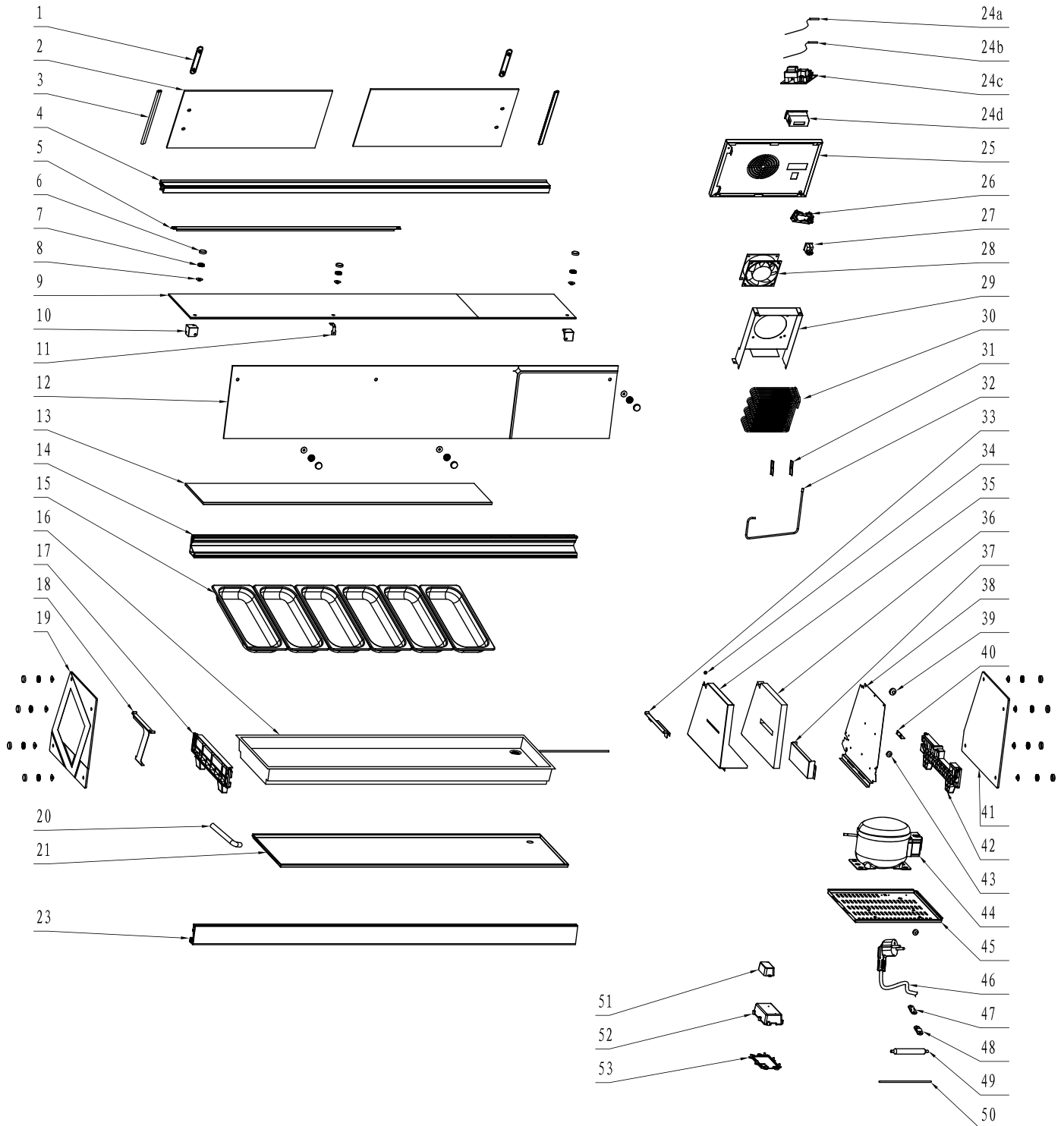

Parts Breakdown

Model RS-CN-0084 44394

Item No.	Description	Position	Item No.	Description	Position	Item No.	Description	Position
66232	Handle for 44394	1	66245	Left Side Glass for 44394	19	66255	Median Septum for 44394	38
66268	Door Glass for 44394	2	60105	Water Discharge Pipe for 44394	20	60756	14mm Protecting Coil for 44394	39
66234	A-Type Sealing Strip for 44394	3	60167	Bottom Panel for 44394	21	66256	Fixed Plate of Median Septum for 44394	40
66269	Upper Pillar for 44394	4	66275	Front Pillar for 44394	23	66257	Right Side Glass for 44394	41
66270	LED for 44394	5	66247	Temperature Controller Assembly for 44394	24	66258	Right Side Plate for 44394	42
60101	Decorating Gasket of Nut for 44394	6	66248	Back Board for 44394	25	66259	12mm Protective Ring for 44394	43
60102	Nut Decorating Parts for 44394	7	60125	Digital Controller Holder for 44394	26	60138	Compressor for 44394	44
60103	Big Gasket of Nut for 44394	8	71514	Switch for 44394	27	66260	Compressor Base Board for 44394	45
66271	Upper Glass for 44394	9	60126	Fan Motor for 44394	28	60115	Power Cord for 44394	46
66238	Fixed Angle for 44394	10	66249	Condenser Backplate for 44394	29	61246	Wire Clip Holder for 44394	47
66239	Glass Bracket for 44394	11	60135	Condenser for 44394	30	61245	Wire Clip Cover for 44394	48
66272	Front Glass for 44394	12	60134	Square Gasket for 44394	31	60144	Dry Filter for 44394	49
66273	Glass Shelf for 44394	13	66250	Joint Pipe for 44394	32	60143	Filling Pipe for 44394	50
66274	Back Pillar for 44394	14	66251	Right Support for Glass Shelf for 44394	33	60145	#6 Driver for 44394	51
60098	1/3 GN Pan for 44394	15	60114	5mm Protective Ring for 44394	34	60137	Controller Box for 44394	52
60166	Foam Material for 44394	16	66252	Cover of Median Septum for 44394	35	60136	Controller Panel for 44394	53
66243	Left Side Plate for 44394	17	66253	EVA Cotton of Median Septum for 44394	36			
66244	Left Support for Glass Shelf for 44394	18	66254	Support of Median Septum for 44394	37			

Parts Breakdown

Model RS-CN-0104 44395

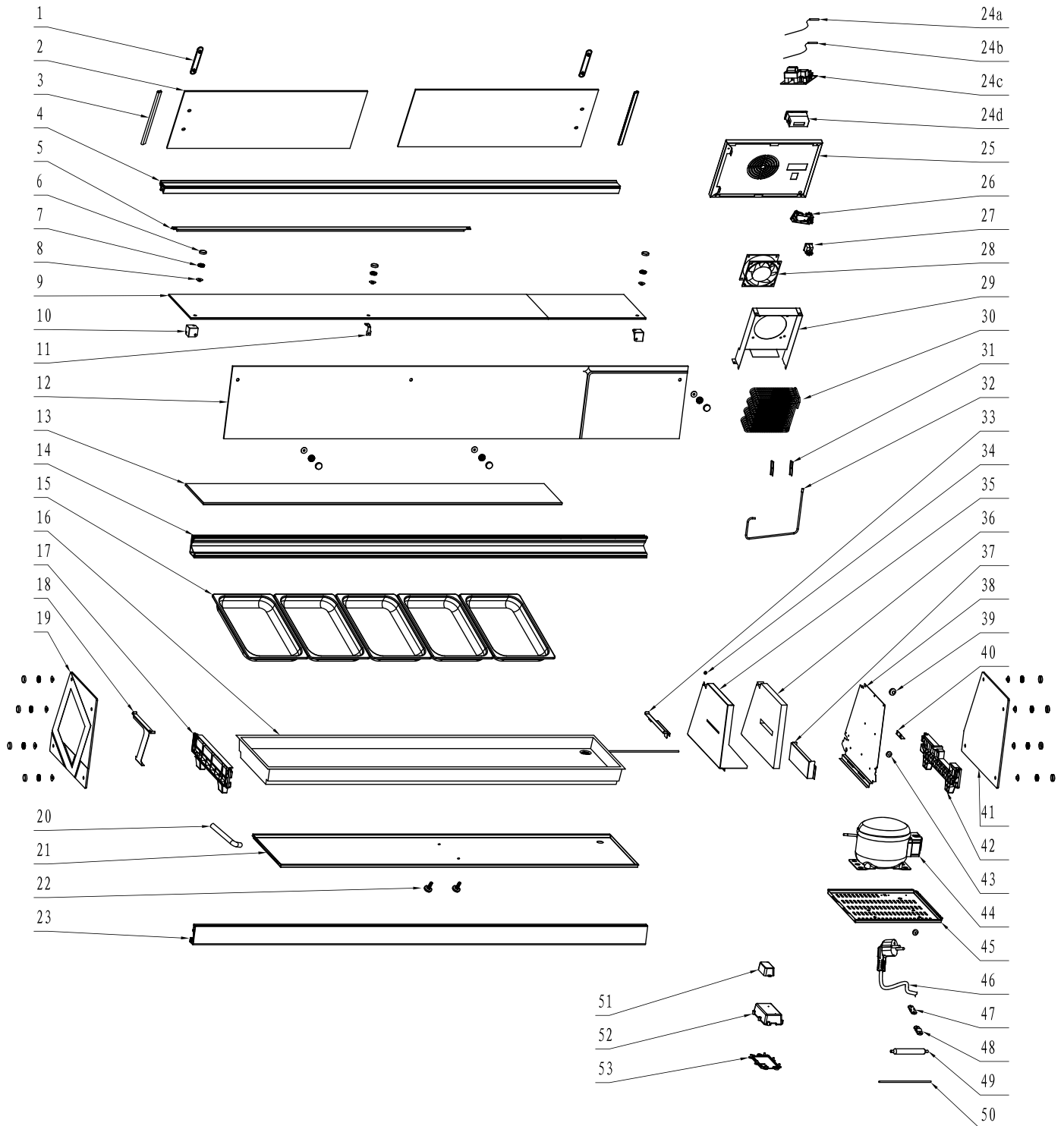

Parts Breakdown

Model RS-CN-0104 44395

Item No.	Description	Position	Item No.	Description	Position	Item No.	Description	Position
66232	Handle for 44395	1	66245	Left Side Glass for 44395	19	66254	Support of Median Septum for 44395	37
66276	Door Glass for 44395	2	60105	Water Discharge Pipe for 44395	20	66255	Median Septum for 44395	38
66234	A-Type Sealing Strip for 44395	3	60180	Bottom Panel for 44395	21	60756	14mm Protecting Coil for 44395	39
66277	Upper Pillar for 44395	4	60181	Adjustable Feet for 44395	22	66256	Fixed Plate of Median Septum for 44395	40
66278	LED for 44395	5	66283	Front Pillar for 44395	23	66257	Right Side Glass for 44395	41
60101	Decorating Gasket of Nut for 44395	6	66247	Temperature Controller Assembly for 44395	24	66258	Right Side Plate for 44395	42
60102	Nut Decorating Parts for 44395	7	66248	Back Board for 44395	25	66259	12mm Protective Ring for 44395	43
60103	Big Gasket of Nut for 44395	8	60125	Digital Controller Holder for 44395	26	60138	Compressor for 44395	44
66279	Upper Glass for 44395	9	71514	Switch for 44395	27	66260	Compressor Base Board for 44395	45
66238	Fixed Angle for 44395	10	60126	Fan Motor for 44395	28	60115	Power Cord for 44395	46
66239	Glass Bracket for 44395	11	66249	Condenser Backplate for 44395	29	61246	Wire Clip Holder for 44395	47
66280	Front Glass for 44395	12	60135	Condenser for 44395	30	61245	Wire Clip Cover for 44395	48
66281	Glass Shelf for 44395	13	60134	Square Gasket for 44395	31	60144	Dry Filter for 44395	49
66282	Back Pillar for 44395	14	66250	Joint Pipe for 44395	32	60143	Filling Pipe for 44395	50
60178	1/2 GN Pan for 44395	15	66251	Right Support for Glass Shelf for 44395	33	66284	#5 Driver for 44395	51
60179	Foam Material for 44395	16	60114	5mm Protective Ring for 44395	34	60137	Controller Box for 44395	52
66243	Left Side Plate for 44395	17	66252	Cover of Median Septum for 44395	35	60136	Controller Panel for 44395	53
66244	Left Support for Glass Shelf for 44395	18	66253	EVA Cotton of Median Septum for 44395	36			

Electrical Schematics

Model RS-CN-0044 43492

Model RS-CN-0064 44393

Model RS-CN-0084 44394

Model RS-CN-0104 44395

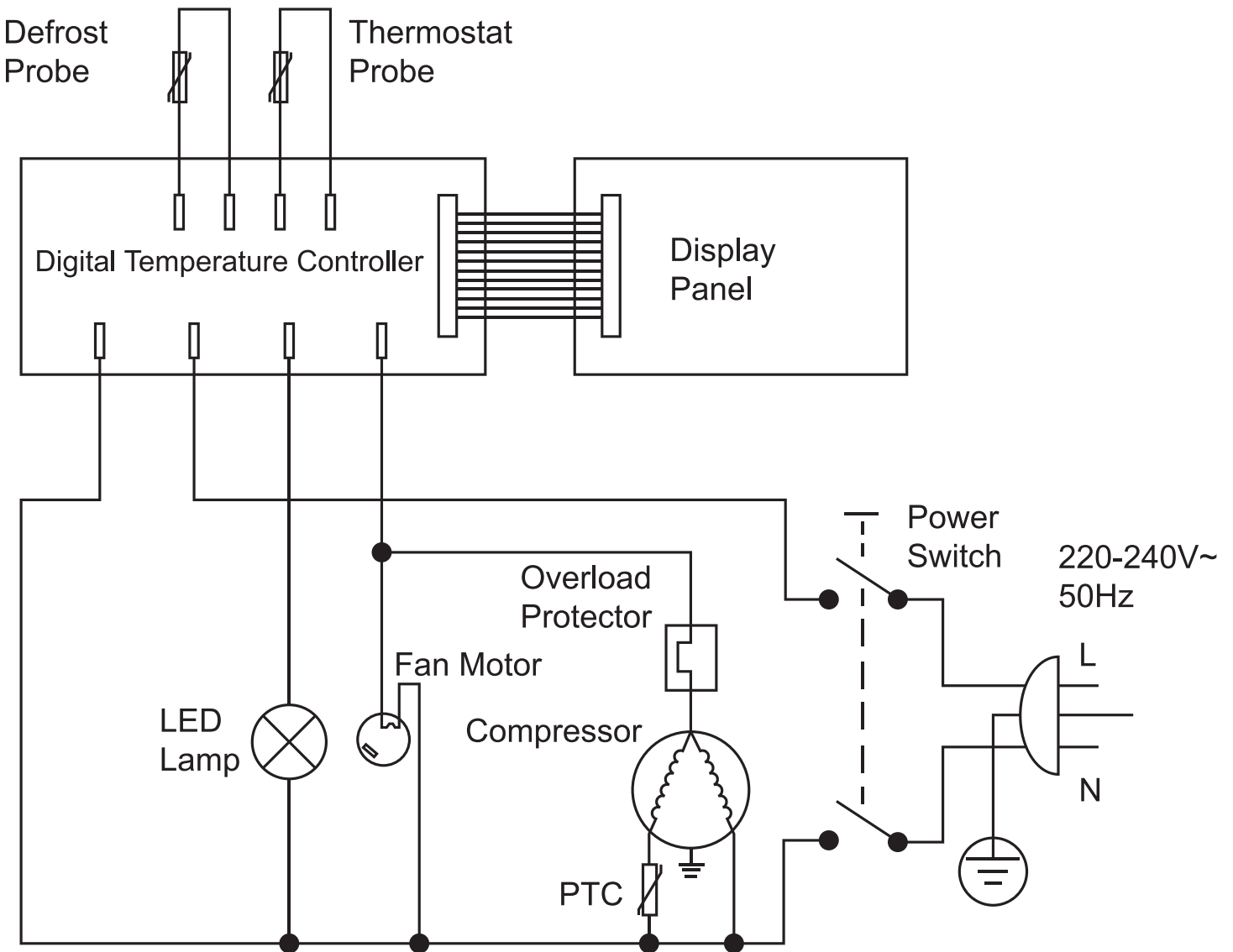

Notes



Warranty Registration

Thank you for purchasing an Omcan product. To register your warranty for this product, complete the information below, tear off the card at the perforation and then send to the address specified below. You can also register online by visiting:

Merci d'avoir acheté un produit Omcan. Pour enregistrer votre garantie pour ce produit, complétez les informations ci-dessous, détachez la carte au niveau de la perforation, puis l'envoyer à l'adresse spécifiée ci-dessous. Vous pouvez également vous inscrire en ligne en visitant:

Gracias por comprar un producto Omcan usted. Para registrar su garantía para este producto, complete la información a continuación, cortar la tarjeta en la perforación y luego enviarlo a la dirección indicada a continuación. También puede registrarse en línea en:

<https://omcan.com/warranty-registration/>

For mailing in Canada

Pour postale au Canada

Por correo en Canadá

OMCAN

PRODUCT WARRANTY REGISTRATION

3115 Pepper Mill Court,

Mississauga, Ontario

Canada, L5L 4X5

For mailing in the US

Pour diffusion aux États-Unis

Por correo en los EE.UU.

OMCAN

PRODUCT WARRANTY REGISTRATION

4450 Witmer Industrial Estates, Unit 4,

Niagara Falls, New York

USA, 14305

or email to: service@omcan.com



Purchaser's Information

Name: _____

Address: _____

City: _____ Province or State: _____ Postal or Zip: _____

Country: _____

Dealer from which Purchased: _____

Dealer City: _____ Dealer Province or State: _____

Invoice: _____

Model Name: _____ Model Number: _____

Machine Description: _____

Date of Purchase (MM/DD/YYYY): _____

Would you like to extend the warranty? Yes No

Company Name: _____

Telephone: _____

Email Address: _____

Type of Company:

Restaurant Bakery Deli

Butcher Supermarket Caterer

Institution (specify): _____

Other (specify): _____

Serial Number: _____

Date of Installation (MM/DD/YYYY): _____

Thank you for choosing Omcan | Merci d'avoir choisi Omcan | Gracias por elegir Omcan



Since 1951 Omcan has grown to become a leading distributor of equipment and supplies to the North American food service industry. Our success over these many years can be attributed to our commitment to strengthen and develop new and existing relationships with our valued customers and manufacturers. Today with partners in North America, Europe, Asia and South America, we continually work to improve and grow the company. We strive to offer customers exceptional value through our qualified local sales and service representatives who provide convenient access to over 6,500 globally sourced products.

Depuis 1951 Omcan a grandi pour devenir un des “leaders” de la distribution des équipements et matériel pour l’industrie des services alimentaires en Amérique du Nord. Notre succès au cours de ces nombreuses années peut être attribué à notre engagement à renforcer et à développer de nouvelles et existantes relations avec nos clients et les fabricants de valeur. Aujourd’hui avec des partenaires en Amérique du Nord, Europe, Asie et Amérique du Sud, nous travaillons continuellement à améliorer et développer l’entreprise. Nous nous efforçons d’offrir à nos clients une valeur exceptionnelle grâce à nos ventes locales qualifiées et des représentants de service qui offrent un accès facile à plus de 6500 produits provenant du monde entier.

Desde 1951 Omcan ha crecido hasta convertirse en un líder en la distribución de equipos y suministros de alimentos en América del Norte industria de servicios. Nuestro éxito en estos años se puede atribuir a nuestro compromiso de fortalecer y desarrollar nuevas relaciones existentes con nuestros valiosos clientes y fabricantes. Hoy con socios de América del Norte, Europa, Asia y América del Sur, que trabajan continuamente para mejorar y crecer la empresa. Nos esforzamos por ofrecer a nuestros clientes valor excepcional a través de nuestro local de ventas y representantes de los servicios que proporcionan un fácil acceso a más de 6,500 productos con origen a nivel mundial.

